

gastroequip

06



Bandejas - Recipientes

Bandejas y accesorios

Bandejas gastronorm acero

Tapas gastronorm acero

Tapas silicona

Bases perforadas

Bandejas policarbonato

Tapas policarbonato

Tapas herméticas

Cubetas de helado

Bandejas tritan

Tapas tritan

Estantes varilla

Separadores

Bandejas

06

Un gran abanico de posibilidades para mantener sus productos perfectamente organizados, sin riesgo sanitario y fácilmente accesibles. Cubetas en medidas gastronorm de acero inoxidable AISI 304 , policarbonato y bandejas de Tritan, nuevo material transparente, extra resistente y tapas en acero, policarbonato, silicona, herméticas, de Tritan, para el vacío, almacenaje, etc.



Bandejas

Gastronorm



Con asas



Perforadas



Tritan™



Policarbonato



Tapas

Gastronorm



Para asas



Hermética



Tritán™



Policarbonato



Silicona



Fondo perforado



Asta divisoria



Bandejas y estantes varilla

Ranurada



Lisa



Acero inoxidable



Recubierta

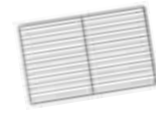

Gastronorm inox 304

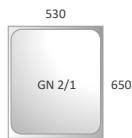

GN 2/1 / Bandejas

Cod.	Ref.	Capacidad	Medida	Precio
F15 1500	GN 2/1 20	5L	650x530x20	29
F15 1501	GN 2/1 40	10L	650x530x40	37
F15 1502	GN 2/1 65	18,5L	650x530x65	42
F15 1503	GN 2/1 100	28,5L	650x530x100	49
F15 1504	GN 2/1 150	42,5L	650x530x150	75
F15 1505	GN 2/1 200	57,5L	650x530x200	81

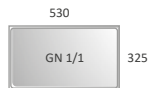

GN 1/1 / Bandejas

Cod.	Ref.	Capacidad	Medida	Precio
F15 1506	GN 1/1 20	2,5L	530x325x20	16
F15 1507	GN 1/1 40	5L	530x325x40	17
F15 1508	GN 1/1 65	9L	530x325x65	19
F15 1509	GN 1/1 100	14L	530x325x100	23
F15 1510	GN 1/1 150	21L	530x325x150	35
F15 1511	GN 1/1 200	28L	530x325x200	48



GN 2/3 / Bandejas

Cod.	Ref.	Capacidad	Medida	Precio
F15 1512	GN 2/3 20	1,5L	354x325x20	14
F15 1513	GN 2/3 40	3L	354x325x40	16
F15 1515	GN 2/3 65	5,5L	354x325x65	18
F15 1516	GN 2/3 100	9L	354x325x100	21
F15 1517	GN 2/3 150	13L	354x325x150	32
F15 1518	GN 2/3 200	18L	354x325x200	43



GN 1/2 / Bandejas

Cod.	Ref.	Capacidad	Medida	Precio
F15 1519	GN 1/2 20	1,25L	325x265x20	9
F15 1520	GN 1/2 40	2L	325x265x40	10
F15 1521	GN 1/2 65	4,5L	325x265x65	12
F15 1522	GN 1/2 100	6L	325x265x100	14
F15 1523	GN 1/2 150	9L	325x265x150	22
F15 1524	GN 1/2 200	12,5L	325x265x200	31



GN 1/3 / Bandejas

Cod.	Ref.	Capacidad	Medida	Precio
F15 1525	GN 1/3 20	0,75L	325x176x20	8,50
F15 1526	GN 1/3 40	1,5L	325x176x40	9
F15 1527	GN 1/3 65	2,5L	325x176x65	10
F15 1528	GN 1/3 100	4L	325x176x100	13
F15 1529	GN 1/3 150	5,7L	325x176x150	24
F15 1530	GN 1/3 200	7,8L	325x176x200	29

Acero Inoxidable AISI 304

Gastronorm inox 304



GN 1/4 / Bandejas

Cod.	Ref.	Capacidad	Medida	Precio
F15 1531	GN 1/4 20	0,5L	265x162x20	8
F15 1532	GN 1/4 40	1L	265x162x40	9,50
F15 1533	GN 1/4 65	1,8L	265x162x65	11
F15 1534	GN 1/4 100	2,8L	265x162x100	13
F15 1535	GN 1/4 150	4L	265x162x150	21
F15 1536	GN 1/4 200	5,5L	265x162x200	28



GN 1/6 / Bandejas

Cod.	Ref.	Capacidad	Medida	Precio
F15 1549	GN 1/6 40	0.4L	176x162x40	7
F15 1537	GN 1/6 65	1L	176x162x65	8
F15 1538	GN 1/6 100	1,6L	176x162x100	10
F15 1539	GN 1/6 150	2,4L	176x162x150	18
F15 1540	GN 1/6 200	3,4L	176x162x200	30



GN 1/9 / Bandejas

Cod.	Ref.	Capacidad	Medida	Precio
F15 1541	GN 1/9 65	0,6L	176x108x65	7
F15 1542	GN 1/9 100	1L	176x108x100	12



GN 2/4 / Bandejas

Cod.	Ref.	Capacidad	Medida	Precio
F15 1544	GN 2/4 20	1L	530x162x20	17
F15 1545	GN 2/4 40	2L	530x162x40	21
F15 1546	GN 2/4 65	3,5L	530x162x65	23
F15 1547	GN 2/4 100	5,5L	530x162x100	31
F15 1548	GN 2/4 150	8,5L	530x162x150	42



Acero Inoxidable AISI 304

Con asas inox 304

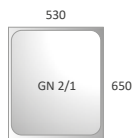

GN 2/1 / Bandejas con asas

Cod.	Ref.	Capacidad	Medida	Precio
F15 1552	GNA 2/1 65	16,5L	650x530x65	55
F15 1553	GNA 2/1 100	26L	650x530x100	65
F15 1554	GNA 2/1 150	40L	650x530x150	101
F15 1555	GNA 2/1 200	55L	650x530x200	113

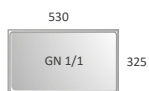

GN 1/1 / Bandejas con asas

Cod.	Ref.	Capacidad	Medida	Precio
F15 1558	GNA 1/1 65	7.4L	530x325x65	27
F15 1559	GNA 1/1 100	12.6L	530x325x100	32
F15 1560	GNA 1/1 150	18L	530x325x150	47
F15 1561	GNA 1/1 200	25L	530x325x200	62



GN 2/3 / Bandejas con asas

Cod.	Ref.	Capacidad	Medida	Precio
F15 1565	GNA 2/3 65	5.25L	354x325x65	25
F15 1566	GNA 2/3 100	8L	354x325x100	29
F15 1567	GNA 2/3 150	8L	354x325x150	42
F15 1568	GNA 2/3 200	8L	354x325x200	51



GN 1/2 / Bandejas con asas

Cod.	Ref.	Capacidad	Medida	Precio
F15 1571	GNA 1/2 65	3.5L	325x265x65	18
F15 1572	GNA 1/2 100	5.5L	325x265x100	20
F15 1573	GNA 1/2 150	8.5L	325x265x150	29
F15 1574	GNA 1/2 200	8.5L	325x265x200	38

Acero Inoxidable AISI 304

Con asas inox 304



GN 1/3 / Bandejas con asas

Cod.	Ref.	Capacidad	Medida	Precio
F15 1577	GNA 1/3 65	2.25L	325x176x65	16
F15 1578	GNA 1/3 100	3.5L	325x176x100	19
F15 1579	GNA 1/3 150	5.5L	325x176x150	32
F15 1580	GNA 1/3 200	7.25L	325x176x200	38



GN 1/4 / Bandejas con asas

Cod.	Ref.	Capacidad	Medida	Precio
F15 1583	GNA 1/4 65	1.5L	265x162x65	16
F15 1584	GNA 1/4 100	2.5L	265x162x100	20
F15 1585	GNA 1/4 150	3.75L	265x162x150	31
F15 1586	GNA 1/4 200	5.25L	265x162x200	42



GN 1/6 / Bandejas con asas

Cod.	Ref.	Capacidad	Medida	Precio
F15 1587	GNA 1/6 65	1L	176x162x65	14
F15 1588	GNA 1/6 100	1.5L	176x162x100	17
F15 1589	GNA 1/6 150	2.25L	176x162x150	23
F15 1590	GNA 1/6 200	3L	176x162x200	37



Acero Inoxidable AISI 304

Perforadas inox 304

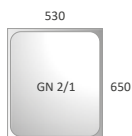

GN 2/1 / Bandejas perforadas

Cod.	Ref.	Capacidad	Medida	Precio
FI5 1601	GNP 2/1 40	10L	650x530x40	56
FI5 1602	GNP 2/1 65	18,5L	650x530x65	65
FI5 1603	GNP 2/1 100	28,5L	650x530x100	78
FI5 1604	GNP 2/1 150	42,5L	650x530x150	119
FI5 1605	GNP 2/1 200	57,5L	650x530x200	135

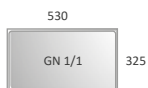

GN 1/1 / Bandejas perforadas

Cod.	Ref.	Capacidad	Medida	Precio
FI5 1606	GNP 1/1 20	2,5L	530x325x20	27
FI5 1607	GNP 1/1 40	5L	530x325x40	29
FI5 1608	GNP 1/1 65	9L	530x325x65	33
FI5 1609	GNP 1/1 100	14L	530x325x100	40
FI5 1610	GNP 1/1 150	21L	530x325x150	55
FI5 1611	GNP 1/1 200	28L	530x325x200	74



GN 2/3 / Bandejas perforadas

Cod.	Ref.	Capacidad	Medida	Precio
FI5 1612	GNP 2/3 20	1,5L	354x325x20	21
FI5 1613	GNP 2/3 40	3L	354x325x40	23
FI5 1614	GNP 2/3 65	5,5L	354x325x65	27
FI5 1615	GNP 2/3 100	9L	354x325x100	32
FI5 1616	GNP 2/3 150	13L	354x325x150	46
FI5 1617	GNP 2/3 200	18L	354x325x200	59



GN 1/2 / Bandejas perforadas

Cod.	Ref.	Capacidad	Medida	Precio
FI5 1619	GNP 1/2 40	2L	325x265x40	16
FI5 1620	GNP 1/2 65	4,5L	325x265x65	18
FI5 1621	GNP 1/2 100	6L	325x265x100	23
FI5 1622	GNP 1/2 150	9L	325x265x150	33
FI5 1623	GNP 1/2 200	12,5L	325x265x200	45

Cubeta helados inox 304



GCH / Bandejas para helados

Cod.	Ref.	Descripción	Medida	Precio
FI5 1690	GCH	Cubeta Helado	360 x 165 x 100	26
FI5 1691	GCH 12	Cubeta Helado	360 x 165 x 120	34
FI5 1692	GCH	Cubeta Helado	360 x 165 x 150	41
FI5 1693	ACH	Cubeta Helado	360 x 165 x 170	46

Acero Inoxidable AISI 304 (Gastronorm)

Policarbonato



GN 1/1 / Bandejas policarbonato

Cod.	Ref.	Capacidad	Medida	Precio
F15 1808	PGN 1/1 65	9L	530x325x65	11
F15 1809	PGN 1/1 100	14L	530x325x100	13
F15 1810	PGN 1/1 150	21L	530x325x150	18
F15 1811	PGN 1/1 200	28L	530x325x200	22



GN 1/2 / Bandejas policarbonato

Cod.	Ref.	Capacidad	Medida	Precio
F15 1821	PGN 1/2 65	4.5L	325x265x65	5
F15 1822	PGN 1/2 100	6L	325x265x100	7
F15 1823	PGN 1/2 150	9L	325x265x150	9
F15 1824	PGN 1/2 200	12.5L	325x265x200	12



GN 1/3 / Bandejas policarbonato

Cod.	Ref.	Capacidad	Medida	Precio
F15 1827	PGN 1/3 65	2.5L	325x176x65	4
F15 1828	PGN 1/3 100	4L	325x176x100	5
F15 1829	PGN 1/3 150	5.7L	325x176x150	7
F15 1830	PGN 1/3 200	7.2L	325x176x200	9



GN 1/4 / Bandejas policarbonato

Cod.	Ref.	Capacidad	Medida	Precio
F15 1833	PGN 1/4 65	1.8L	265x162x65	3
F15 1834	PGN 1/4 100	2.8L	265x162x100	4
F15 1835	PGN 1/4 150	4L	265x162x150	5



GN 1/6 / Bandejas policarbonato

Cod.	Ref.	Capacidad	Medida	Precio
F15 1837	PGN 1/6 65	1L	176x162x65	3
F15 1838	PGN 1/6 100	1.6L	176x162x100	4
F15 1839	PGN 1/6 150	2.4L	176x162x150	5



GN 1/9 / Bandejas policarbonato

Cod.	Ref.	Capacidad	Medida	Precio
F15 1841	PGN 1/9 65	0.6L	176x108x65	2
F15 1842	PGN 1/9 100	1L	176x108x100	3
F15 1843	PGN 1/9 150	1L	176x108x150	4

Tapas inox 304



GNT / Tapas estándar

Cod.	Ref.	Descripción	Medida	Precio
F15 1700	GNT 2/1	Tapa GN 2/1	530 x 650	37
F15 1701	GNT 1/1	Tapa GN 1/1	530 x 325	19
F15 1702	GNT 2/3	Tapa GN 2/3	354 x 325	15
F15 1703	GNT 1/2	Tapa GN 1/2	325 x 265	12
F15 1704	GNT 1/3	Tapa GN 1/3	325 x 176	9.50
F15 1705	GNT 1/4	Tapa GN 1/4	265 x 162	8
F15 1706	GNT 1/6	Tapa GN 1/6	176 x 162	6.50
F15 1707	GNT 1/9	Tapa GN 1/9	176 x 108	5
F15 1708	GNT 2/4	Tapa GN 2/4	530 x 162	14

Acero Inoxidable AISI 304



GNTH / Tapas herméticas

Cod.	Ref.	Descripción	Medida	Precio
F15 1711	GNTH 1/1	Tapa Hermetica GN 1/1	530 x 325	62
F15 1712	GNTH 2/3	Tapa Hermetica GN 2/3	354 x 325	50
F15 1713	GNTH 1/2	Tapa Hermetica GN 1/2	325 x 265	40
F15 1714	GNTH 1/3	Tapa Hermetica GN 1/3	325 x 176	34
F15 1715	GNTH 1/4	Tapa Hermetica GN 1/4	265 x 162	32
F15 1718	GNTH 2/4	Tapa Hermetica GN 2/4	530 x 162	49

Acero Inoxidable AISI 304



GNN / Tapas para bandejas con asas

Cod.	Ref.	Descripción	Medida	Precio
F15 1720	GN 2/1	Tapa para bandejas c/asas GN 2/1	530 x 650	42
F15 1721	GN 1/1	Tapa para bandejas c/asas GN 1/1	530 x 325	24
F15 1722	GN 2/3	Tapa para bandejas c/asas GN 2/3	325 x 354	18
F15 1723	GN 1/2	Tapa para bandejas c/asas GN 1/2	325 x 265	15
F15 1724	GN 1/3	Tapa para bandejas c/asas GN 1/3	325 x 176	12
F15 1725	GN 1/4	Tapa para bandejas c/asas GN 1/4	265 x 162	10
F15 1726	GN 1/6	Tapa para bandejas c/asas GN 1/6	176 x 162	8
F15 1728	GN 2/4	Tapa para bandejas c/asas GN 2/4	530 x 162	18

Acero Inoxidable AISI 304



GNTP / Tapas policarbonato

Cod.	Ref.	Descripción	Medida	Precio
F15 1731	GNTP 1/1	Tapa Policarbonato GN 1/1	530x325	9
F15 1732	GNTP 1/2	Tapa Policarbonato GN 1/2	325x265	6
F15 1733	GNTP 1/3	Tapa Policarbonato GN 1/3	325x176	5
F15 1734	GNTP 1/4	Tapa Policarbonato GN 1/4	265x162	4
F15 1735	GNTP 1/6	Tapa Policarbonato GN 1/6	176x162	3
F15 1736	GNTP 1/9	Tapa Policarbonato GN 1/9	176x108	2

Tapas de silicona

Novedad

Utilización en: CONGELACION (Temperatura máx.- 30°C); COCCION (Temp. Máxima 200 °C / 2 Horas) MICROONDAS (Máximo 10 minutos)
Cierre hermético evitando el uso de aluminio o film. Flexibles, reutilizables, lavables, duraderas y ergonómicas. La tapa se adapta perfectamente en todo tipo de formatos GN de la mayoría de marcas. Utilizable en acero inoxidable, polipropileno, policarbonato, Tritan, etc. Mantiene frescos los alimentos y ayuda a prevenir la contaminación cruzada. Son totalmente herméticas, incluso para guardar líquidos. Higienizable en lavavajillas



GTS / Tapas silicona

Cod.	Ref.	Descripción	Medida	Precio
F15 1740	GTS 11	Tapa Silicona GN 1/1	530x325	10
F15 1741	GTS 12	Tapa Silicona GN 1/2	325x265	8
F15 1742	GTS 13	Tapa Silicona GN 1/3	325x176	6
F15 1743	GTS 14	Tapa Silicona GN 1/4	265x162	5
F15 1744	GTS 16	Tapa Silicona GN 1/6	176x162	4
F15 1745	GTS 19	Tapa Silicona GN 1/9	176x108	3

Fondos perforados inox 304



GN BP / Base fondo

Cod.	Ref.	Descripción	Medida	Precio
F15 1761	GN BP 1/1	Fondo base perforada	530 x 325	30
F15 1762	GN BP 1/2	Fondo base perforada	325 x 265	16
F15 1763	GN BP 1/3	Fondo base perforada	325 x 176	12

Separadores inox 304



GN B / Separador

Cod.	Ref.	Descripción	Medida	Precio
F15 1770	GN B 1/1	Barra Divisoria GN 1/1	325	9
F15 1771	GN B 2/1	Barra Divisoria GN 2/1	530	12

Tapas para vacío / Tritan™

Novedad

Convierta sus cubetas Gastronorm en recipientes de envasado al vacío. Tapas transparentes, fácil utilización. Cierre hermético por junta de silicona. Válvula de seguridad Se adapta a las medidas Gastronorm indicadas. Mantenga sus alimentos frescos o cocinados por más días. Alimentos fresco por más tiempo, bien organizados. Ahorre dinero aprovechando ofertas de compra y prolongando la vida útil de sus alimentos o preparados. Diseñadas para uso profesional e industrial en cocinas para la conservación de alimentos como vegetales, verduras, carnes pre-elaboradas, salsas, postres y otros alimentos durante más días en perfectas condiciones. Vitaminas, Minerales, Nutrientes y sabores quedan protegidos. Se detiene la multiplicación de mohos y bacterias. Evita la mezcla de olores en el frigorífico o congelador. La bandejas son completamente transparentes para identificar de inmediato cualquier producto almacenado. Confeccionadas en Eastman Tritan™, de alta calidad, extra resistente al impacto, no absorbe olores o colores del material envasado, libre de BPA (Bisphenol A).



BTT / Tapas de vacío con válvula

Cod.	Ref.	Descripción	Peso	Precio
F15 1775	BTT11	Tapa vacío con válvula GN 1/1	2,4 Kg.	115
F15 1776	BTT12	Tapa vacío con válvula GN 1/2	1,1 Kg.	55
F15 1777	BTT13	Tapa vacío con válvula GN 1/3	620 gr.	38
F15 1778	BTT14	Tapa vacío con válvula GN 1/4	480 gr.	33
F15 1779	BTT16	Tapa vacío con válvula GN 1/6	250 gr.	27
F15 1780	BTT19	Tapa vacío con válvula GN 1/9	190 gr.	22



Válvulas de las tapas y la junta de estanqueidad son de silicona.
6 medidas Gastronorm: GN 1/1, GN 1/2, GN 1/3, GN 1/4, GN 1/6 y GN 1/9.



Recomendamos por su facilidad de uso, dimensiones y practicidad nuestra bomba de vacío eléctrica código F15 5606.
Disponible en este mismo catálogo en nuestra familia Otros Cocina, Envasadoras.

Contenedores Tritan™

Novedad

Alimentos frescos por más tiempo, bien organizados. Ahorre dinero aprovechando ofertas de compra y prolongando la vida útil de sus alimentos o preparados. Diseñadas para uso profesional e industrial en cocinas para la conservación de alimentos como vegetales, verduras, carnes pre-elaboradas, salsas, postres y otros alimentos durante más días en perfectas condiciones. Almacenamiento en vacío para preservar la calidad de los alimentos y prolongar su vida útil. Vitaminas, Minerales, Nutrientes y sabores quedan protegidos. Se detiene la multiplicación de mohos y bacterias. Evita la mezcla de olores en el frigorífico o congelador. La bandejas son completamente transparentes para identificar de inmediato cualquier producto almacenado. Confeccionadas en **Eastman Tritan™**, de alta calidad, extra resistente al impacto, no absorbe olores o colores del material envasado, libre de BPA (Bisphenol A). Válvulas de las tapas y la junta de estanqueidad son de Silicona. 5 volúmenes de almacenamiento: 2, 4, 6, 8 y 10 Litros. Todas las bandejas son de medidas: 225 x 225 mm, solo modificándose la altura, siendo por ello fácilmente apilables estando vacías.



BT / Contenedores tritan™ con tapa de vacío

Cod.	Ref.	Descripción	Precio
F15 1852	BT2T	Contenedor Tritan 2 Lts con tapa vacío	31
F15 1854	BT4T	Contenedor Tritan 4 Lts con tapa vacío	34
F15 1856	BT6T	Contenedor Tritan 6 Lts con tapa vacío	38
F15 1858	BT8T	Contenedor Tritan 8 Lts con tapa vacío	45
F15 1860	BT10T	Contenedor Tritan 10 Lts con tapa vacío	51
F15 1850	BTT	Tapa vacío contenedor tritán	19



Recomendamos por su facilidad de uso, dimensiones y practicidad nuestra bomba de vacío eléctrica código F15 5606.

TABLA COMPARATIVA DE ALMACENAJE DE ALIMENTOS

Tipo de alimento	Conservación en frío	Vacío en frío
Alimentos cocinados	2 días	10 días
Carnes en fresco	2-3 días	> 6 días
Carnes cocinadas	4- 5 días	8- 10 días
Pescado Fresco	2- 3 días	4 - 5 días
Fiambres, Salami ahum.	7 días	15- 18 días
Quesos curados	10- 12 días	25- 35 días
Quesos blandos	5- 7 días	13- 15 días
Verduras crudas	5 días	18- 20 días
Hojas ensalada enjuag.	3 días	5- 8 días
Fruta fresca	8- 10 días	8- 20 días
Pan	3- 4 días	7- 8 días
Postres	5 días	15- 20 días



NOTA :

La tabla enumera simplemente la vida útil estimada, porque está sujeta a variables como el estado inicial (frescura) de los alimentos o la forma en que se prepararon. Suponemos que la comida se almacena en la nevera a una temperatura de + 3°C / + 5°C.

Bandejas panadería



ABRA46 / Aluminio ranurado

Cod.	Ref.	Descripción	Medida	Precio
F15 9230	ABRA 46	Bandeja aluminio ranurado panadería	600 x 400	40

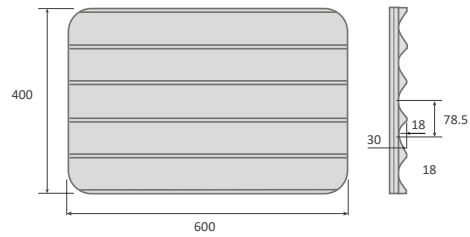

ABLA46 / Aluminio liso

Cod.	Ref.	Descripción	Medida	Precio
F15 9231	ABLA46	Bandeja aluminio liso panadería	600 x 400	24

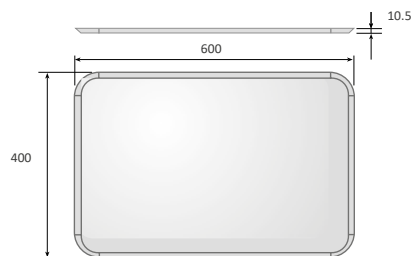

Parrillas estante varilla

AEVGN11

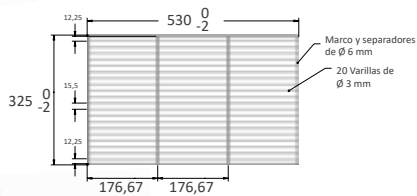

AEVGN21

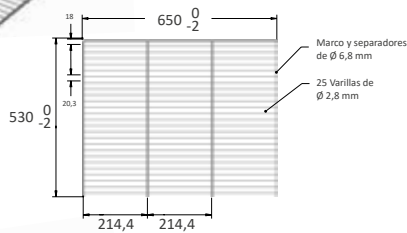

AEV4060

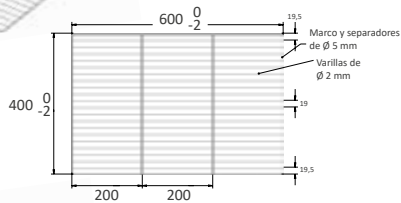

AEVPGN11

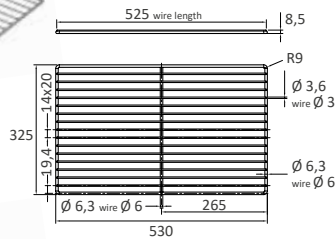

AEVPGN21

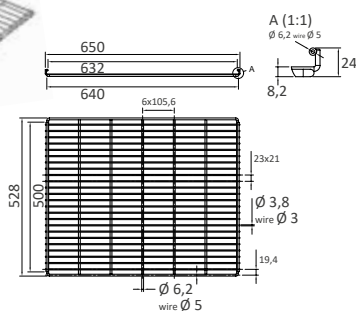

AEV / Varillas

Cod.	Ref.	Descripción	Medida	Precio
F15 1750	AEVGN11	Estante Varilla Inoxidable GN 1/1	530 x 325	19
F15 1751	AEVGN21	Estante Varilla Inoxidable GN 2/1	530 x 650	35
F15 1752	AEV4060	Estante Varilla Inoxidable 40/60	400 x 600	22

AEVPGN / Acero con recubrimiento plástico

Cod.	Ref.	Descripción	Medida	Precio
F15 1755	AEVPGN11	acero recubrimiento plástico GN 1/1	530 x 325	12
F15 1756	AEVPGN21	acero recubrimiento plástico GN 2/1	530 x 650	30