

07



ACCESORIOS

Higiene / Dispensadores / Accesorios acero / Gomas desbarrace
Filtros / Ruedas / Evaporadoras / Lamparas calor / Iluminación Led



ADT / Termómetro digital infrarrojos







Cod.	Ref.	Descripción	Medidas	Precio
FIS 9590	ADT	Termómetro digital	96 x 43 x H 140	109

Rango de temperatura:	35-45 °C.
Exactitud:	+0,2 °C.
Incrementos:	0,1 °C.
Tiempo de medición:	1 segundo.
Distancia:	5-8 cm.
Apagado automático:	15 segundos.
Peso:	158 g.
Rango de humedad:	10-90%.
Baterías:	DC3V (2 AAA)



ADCRP / Dispensador gel / columna con pedal

Cod.	Ref.	Descripción	Medidas	Precio
FIS 9463	ADCRP	Dispensador gel 1L.	120 x H 1200	325

			
Acción por pedal	Operación sin contacto	Capacidad 1.000 ml.	Diseño compacto
			
Gel hidroalcolólico	Solución hidroalcolólica	Fácil mantenimiento	

Principales características:

Construcción:	Acero Inoxidable AISI 304
Diámetro columna:	12 cm.
Altura:	1200 cm.
Capacidad gel:	1.000 ml.



ADECAS / Dispensador Electrónico columna

Cod.	Ref.	Descripción	Medidas	Precio
F15 9459	ADCAS	Electr./ Alcohol-spay 3L	314 x 230 x H 1163	825

Sensor por infrarrojos	Operación sin contacto	Uso Intensivo	Capacidad 3.000 ml.	Depósito recogida 500 ml.
Gel hidroalcolico 1ml.	Solución hidroalcolica 1ml.	Diseño compacto	Fácil mantenimiento	Uso Interior / Exterior

CARACTERÍSTICAS TÉCNICAS

Tensión de entrada de 110/230 Vac frecuencia de 50/60 Hz.

Detector de proximidad por infrarrojo para la activación del nebulizador.

El detector asegura una dosis precisa de 2 segundos.

Sistema de seguridad que evita que la bomba pueda funcionar

de forma continuada en caso que se obstruya el sensor de proximidad.

Cuenta con una bomba de 12V/3A y 1,5bar.

Retroiluminación de LED.



Los complementos se venden por separado

ACAH / Columna accesorios / ajustable lacada

Cod.	Ref.	Descripción	Medidas	Precio
F15 9464	ACAH	Columna ajustable	400 x 400 x H 1800	315

Columna Accesorios higiene

Acabado lacado

Posicionamiento regulable

Papelera, Guantes, Mascarillas y Gel en un único espacio

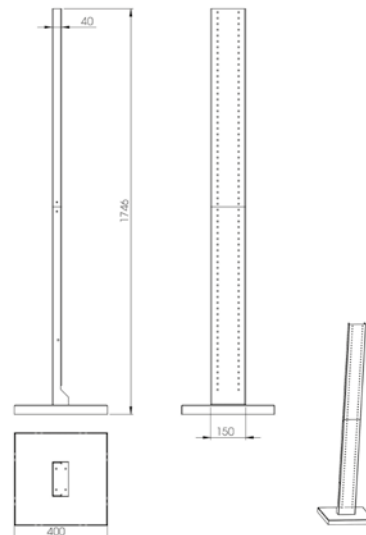

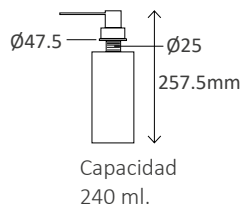

ADME / Dosificador manual encastrable

Cod.	Ref.	Descripción	Medidas	Precio
F15 9461	ADME	240 ml.	47,5 x 257.5 (h)	36

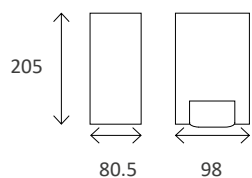

ADJ / Dosificador jabón manual granel

Cod.	Ref.	Descripción	Medidas	Precio
F15 9460	ADJ	600 ml	98 x 80 x 205 (h)	28



ADMI / Dosificador jabón manual inoxidable

Cod.	Ref.	Descripción	Medidas	Precio
F15 9469	ADMI	1000 ml	126 x 72 x 210 (h)	42



ADTPI / Dispensador toallas plegadas / Inoxidable

Cod.	Ref.	Descripción	Medidas	Precio
F15 9467	ADTPI	Dispensador bajo	270 x 100 x H 220	46
F15 9468	ADTPIA	Dispensador alto	270 x 100 x H 350	51

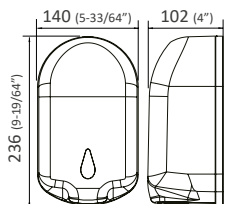

AD / Dispensador electrónico automático

Cod.	Ref.	Descripción	Medidas	Precio
F15 9455	ADEG	Electrón./ Gel / 1.1L	140 x 106 x H 236	105
F15 9456	ADEAS	Electrón./ Alcohol 1L	140 x 106 x H 236	105

- Sensor por infrarrojos
- Operación sin contacto
- Alimentación 4 pilas AA
- Gel hidroalcolólico 1ml.
- Solución hidroalcolólica 1ml.

Modelos	ADEG	ADEAS
Motor	DC 1400 mpm	DC 1400 mpm
Tensión	DC 6V.-4 pilas AA	DC 6V.-4 pilas AA
Capacidad	1000ml.	1000ml.
Rango sensor	3-10cm.	3-10cm.
Vida batería	70.000 ciclos	70.000 ciclos
Temperatura estancia	5- 40°C	5- 40°C
Material	Plastico ABS alto impacto	
Peso	0.7 kg.	0.7 kg.
Uso	Gel Jabón Desinfeccion	Alcohol spray

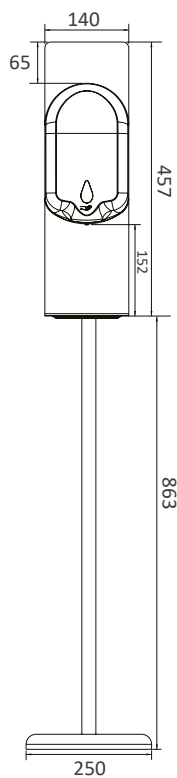

ADEP / Dispensador electrónico de pie

Cod.	Ref.	Descripción	Medidas	Precio
F15 9457	ADEPG	Elect. / Gel 1.1L	140 x H 1650	150
F15 9458	ADEPAS	Elect. / Alcohol spray 1.1L	140 x H 1650	150

- Sensor por infrarrojos
- Operación sin contacto
- Alimentación 4 pilas AA
- Capacidad 1.100 ml.
- Gel hidroalcolólico 1ml.
- Solución hidroalcolólica 1ml.
- Diseño compacto
- Fácil mantenimiento

Principales características:

Tipo de motor:	DC, 1400 rpm, 0,5W
Alimentación:	4 pilas AA (70.000 ciclos de duración)
Capacidad:	1.100 ml.
Dosis:	1 ml.
Rango del sensor:	3 a 10 cm.
Peso:	0,7 Kg.

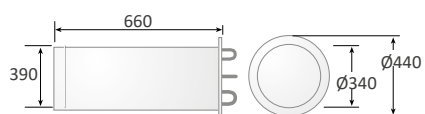

ADP / Dispensador de platos / Inoxidable 18/8

Cod.	Ref.	Descripción	Peso	Precio
F15 9410	ADPN1824	Neutro 180-260mm	11 Kg	475
F15 9415	ADPC1824	Calefactado 180-260mm	11.5 Kg	770
F15 9411	ADPN2432	Neutro 240-320mm	11 Kg	615
F15 9416	ADPC2432	Calefactado 240-320mm	11.5 Kg	790
F15 9412	ATDP1826	Tapa Ø325mm. 180-260mm	265 gr	85
F15 9413	ATDP2432	Tapa Ø400mm. 240-320mm	435 gr	85

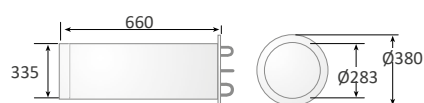

ADVA / Dispensador de vasos / Inoxidable 18/8

Cod.	Ref.	Descripción	Peso	Precio
F15 9420	ADVA6475	para vasos 64-75mm.	1.3 Kg	79
F15 9421	ADVA7590	para vasos 75-90mm.	1.6 Kg	89

Acero Inoxidable 18/8
Permite regular la boca para distintos diámetros de vasos
Longitud del tubo 585 mm

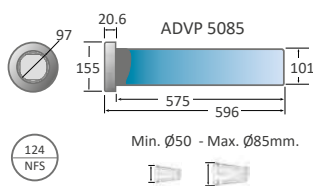
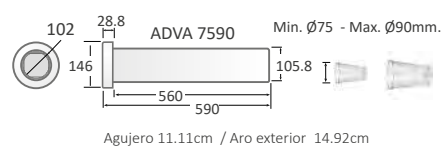
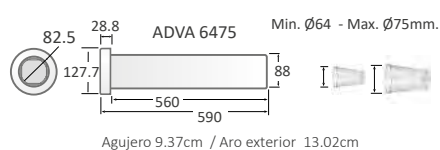

ADVP 5085 / Dispensador de vasos / Plástico

Cod.	Ref.	Descripción	Peso	Precio
F15 9422	ADVP5085	para vasos 50-85mm.	1.4 Kg	129

Vaso: 118- 710 ml.
Diámetro del borde: 62-92 mm.
Longitud del tubo: 603 mm



ACJGP / Cajones cafeteros

Cod.	Ref.	Descripción	Precio
F15 9214	ACJGP7	con barra picamarros	164
F15 9210	ACJGP9	sin barra picamarros	125

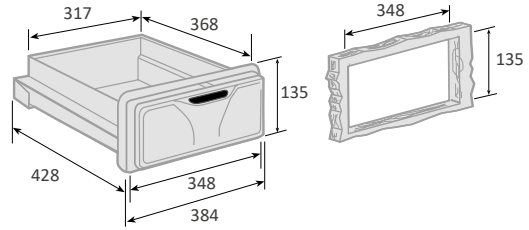

ACGP-42 / Cajonera doble

Cod.	Ref.	Descripción	Precio
F15 9212	ACGP-42	Cajón doble	265

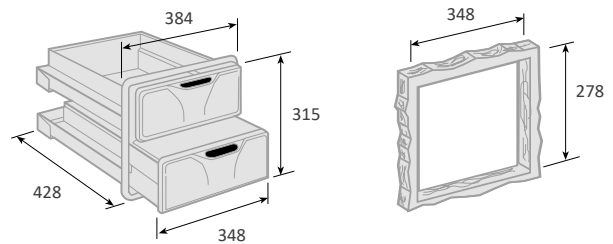

ATVGG-1 / Tolva volquete café

Cod.	Ref.	Descripción	Precio
F15 9211	ATVGG-1	Tolva volquete picamarro	180

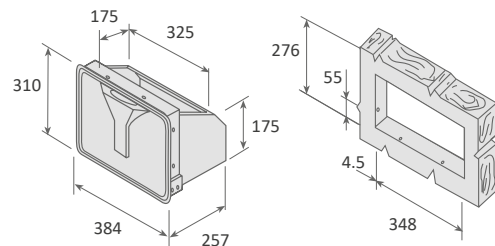

ABP45 / Barra picamarro

Cod.	Ref.	Descripción	Precio
F15 9213	ABP45	Barra picamarro	26

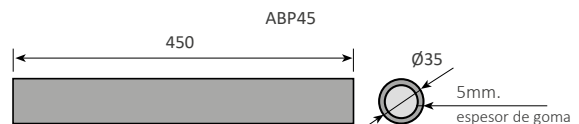



ATGD / Tapas acero inoxidable AISI 304 18/8

Cod.	Ref.	Descripción	Medidas	Peso	Precio
F15 9245	ATGD-234	Tapa inoxidable	237.6 x 30	400 gr	43
F15 9246	ATGD-278	Tapa inoxidable	281.6 x 30	524 gr	46

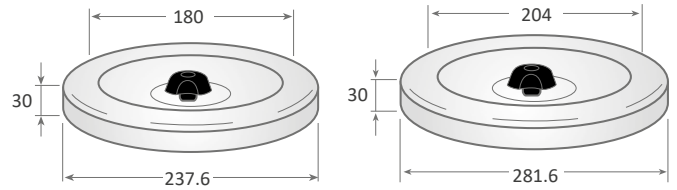

AGDN / Goma desbroce / Epm

Cod.	Ref.	Descripción	Color	Peso	Precio
F15 9240	AGDN-234	Goma 234 x 166	Negro	630 gr	14
F15 9242	AGDN-278	Goma 278 x 210	Negro	942 gr	18
F15 9237	AGDR-234	Goma 234 x 166	Rojo	630 gr	16
F15 9238	AGDA-234	Goma 234 x 166	Amarillo	630 gr	16
F15 9239	AGDV-234	Goma 234 x 166	Verde	630 gr	16
F15 9241	AGDZ-234	Goma 234 x 166	Azul	630 gr	16

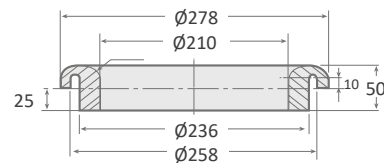
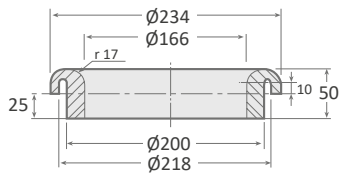

ATGN-250 / Tapa con aro / acero inoxidable

Cod.	Ref.	Descripción	Medidas	Peso	Precio
F15 9248	ATGN-250	Tapa + aro inox.	250 x 16	566 gr	39



AGDN-250 / Goma desbroce grande / Caucho

Cod.	Ref.	Descripción	Medidas	Peso	Precio
F15 9244	ADGN-250	Goma desbroce	234 x 68	1.1 Kg	38

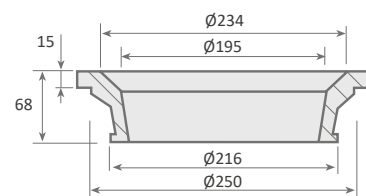

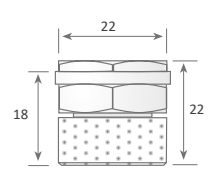
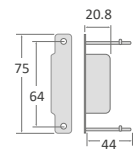

Filtros para campana / Acero inoxidable

Cod.	Ref.	Descripción	Medidas	Peso	Precio
F15 9190	AFLF-5050	Filtro lamas 430	500x500x20	2 Kg	36
F15 9191	AFLF-4545	Filtro lamas 430	450x450x20	1.6 Kg	35
F15 9192	AFLF-4040	Filtro lamas 430	400x400x20	1.3 Kg	29
F15 9193	AFLF-5040	Filtro lamas 430	500x400x20	1.6 Kg	36
F15 9194	AFLF-5030	Filtro lamas 430	500x300x20	1.2 Kg	31
F15 9195	AFLF-3050	Filtro lamas 430	300x500x20	1.2 Kg	27
F15 9199	ATFL-1	Tirador para filtro		35 gr	2
F15 9200	AFL-304	Filtro 18/8 (304)	490x490x50	2.5 Kg	41
F15 9201	AFL-430	Filtro (430)	490x490x50	2 Kg	30
F15 9206	AFL-304-39	Filtro 18/8 (304)	490x390x50	1.9 Kg	29
F15 9205	AFL-430-39	Filtro (430)	490x390x50	1.9 Kg	24



AVD / Válvula de vaciado para campana

Cod.	Ref.	Descripción	Peso	Precio
F15 9198	ADV	Válvula de vaciado	35 gr.	8



Ciclo: 1.000 cc. agua en 5 horas a una temperatura media de 20° C. sin humedad excesiva.

Especificaciones eléctricas
Capacidad: 1,5 L.

Fabricada en aluminio refractado y provista de muelles anti vibración

ABDE / Bandejas evaporadoras

Cod.	Ref.	Descripción	Peso	Precio
F15 9220	ABDE	Evaporadora 300W	1.2 Kg	80
F15 9221	ABDE-2	Evaporadora 160W	1.2 Kg	80
F15 9222	ABDET	Evaporadora 300W	1.3 Kg	86

Fabricada en aluminio refractado y provista de muelles anti vibración



Con termostato

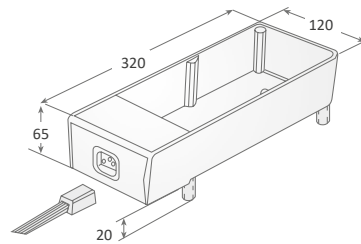

ABDE / Bandeja evaporadora vاملpen

Cod.	Ref.	Descripción	Peso	Precio
F15 9225	ABDE27	Evaporadora 270W	509 gr	60
F15 9226	ABDE18	Evaporadora 180W	487 gr	60

Bandeja fabricada en vاملpen 3026 VO CB color negro.
Cartucho fabricado en AISI 304
Cable de cobre y silicona
Conforme a norma UNEEN 60335-1 y normativa ROHS
Temperatura de uso :-20 a + 100 ° C

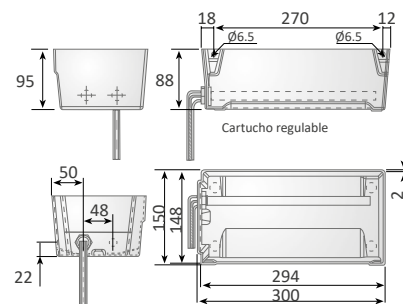
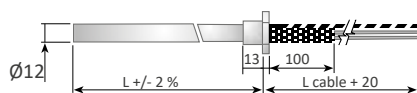

Nylon



Rueda / nylon / con/sin freno / con pletina

Cod.	Ref.	Descripción	Precio
FI5 9250	ARPN-75	75mm. / sin freno / pletina	11
FI5 9251	ARPNF-75	75mm. / con freno / pletina	13

Capacidad de carga: 90 Kg



Rueda / nylon / con/sin freno / con tornillo M-12

Cod.	Ref.	Descripción	Precio
FI5 9252	ARTN-75	75mm. / sin freno / tornillo	11
FI5 9253	ARTNF-75	75mm. / con freno / tornillo	13

Capacidad de carga: 90 Kg



Rueda / nylon / con/sin freno / con pletina

Cod.	Ref.	Descripción	Precio
FI5 9271	ARPN-100	100mm. / sin freno / pletina	12
FI5 9272	ARPNF-100	100mm. / con freno / pletina	14

Capacidad de carga: 100 Kg



Rueda / nylon / con/sin freno / con tornillo M-12

Cod.	Ref.	Descripción	Precio
FI5 9273	ARTN-100	100mm. / sin freno / tornillo	11
FI5 9274	ARTNF-100	100mm. / con freno / tornillo	14

Capacidad de carga: 100 Kg



Cod.

∅ Diam
mm

Banda rodadura
mm

Capacidad de carga
kg

Altura
mm

Altura
mm

Pletina
mm

Métrica de espárrago
mm

FI5 9250 / FI5 9251

75

28

90

108

--

95 x 64

M-12

FI5 9252 / FI5 9253

75

28

90

--

110

--

12 x 25

FI5 9271 / FI5 9272

100

30

100

133

--

95 x 64

M-12

FI5 9273 / FI5 9274

100

30

100

--

135

--

12 x 25

Nylon



Rueda / nylon / con/sin freno / con pletina

Cod.	Ref.	Descripción	Precio
F15 9279	ARPN-125	125mm. / sin freno / pletina	13
F15 9280	ARPNF-125	125mm. / con freno / pletina	15

Capacidad de carga: 120 Kg



Rueda / nylon / con/sin freno / con tornillo M-12

Cod.	Ref.	Descripción	Precio
F15 9281	ARTN-125	125mm. / sin freno / tornillo	12
F15 9282	ARTNF-125	125mm. / con freno / tornillo	15

Capacidad de carga: 120 Kg



Ø Diam
mm



Banda rodadura
mm



Capacidad de carga
Kg



Altura
mm



Altura
mm



Pletina
mm



Métrica de espárrago
mm

Cod.

F15 9279 / F15 9280

125

30

120

160

--

95 x 64

M-12

F15 9281 / F15 9282

125

30

120

--

162

--

12 x 25

Caucho



Rueda / caucho / con/sin freno / con pletina

Cod.	Ref.	Descripción	Precio
FI5 9275	ARPC-100	100mm. / sin freno / pletina	12
FI5 9276	ARPCF-100	100mm. / con freno / pletina	15

Capacidad de carga: 80 Kg



Rueda / caucho / con/sin freno / con tornillo

Cod.	Ref.	Descripción	Precio
FI5 9277	ARTC-100	100mm. / sin freno / tornillo	12
FI5 9278	ARTCF-100	100mm. / con freno / tornillo	14

Capacidad de carga: 80 Kg



Rueda / caucho / con/sin freno / con pletina

Cod.	Ref.	Descripción	Precio
FI5 9283	ARPC-125	125mm. / sin freno / pletina	14
FI5 9284	ARPCF-125	125mm. / con freno / pletina	17

Capacidad de carga: 90 Kg



Rueda / caucho / con/sin freno / con tornillo

Cod.	Ref.	Descripción	Precio
FI5 9285	ARTC-125	125mm. / sin freno / tornillo	14
FI5 9286	ARTCF-125	125mm. / con freno / tornillo	16

Capacidad de carga: 90 Kg



240 °C

Rueda para calor / Fibra de vidrio DMC / sin freno

Cod.	Ref.	Descripción	Precio
FI5 9254	ARFP-100	100mm. / sin freno / pletina	28

Capacidad de carga: 100 Kg

Cod.	Ø Diam mm	Banda rodadura mm	Capacidad de carga Kg	Altura mm	Altura mm	Pletina mm	Métrica de espárrago mm			
FI5 9275 / FI5 9276	100	30	80	133	--	95 x 64	--			
FI5 9277 / FI5 9278	100	30	80	--	135	--	12 x 25			
FI5 9283 / FI5 9284	125	30	90	160	--	95 x 64	--			
FI5 9285 / FI5 9286	125	30	90	--	162	--	12 x 25			
FI5 9254	100	30	100	132	135	95 x 64	--	34	41	8

Acero inoxidable



Rueda / acero inoxidable-nylon / con/sin freno / con pletina

Cod.	Ref.	Descripción	Precio
FI5 9255	ARPNI-100	100mm. / sin freno / pletina	29
FI5 9256	ARPNI-100	100mm. / con freno / pletina	40

Capacidad de carga: 110 Kg



Rueda / acero inoxidable-nylon / con/sin freno / con tornillo

Cod.	Ref.	Descripción	Precio
FI5 9257	ARTNI-100	100mm. / sin freno / tornillo	26
FI5 9258	ARTNI-100	100mm. / con freno / tornillo	38

Capacidad de carga: 110 Kg



Rueda / acero inoxidable-caucho / con/sin freno / con pletina

Cod.	Ref.	Descripción	Precio
FI5 9265	ARPCI-100	100mm. / sin freno / pletina	31
FI5 9266	ARPCI-100	100mm. / con freno / pletina	42

Capacidad de carga: 80 Kg



Rueda / acero inoxidable-caucho / con/sin freno / con tornillo

Cod.	Ref.	Descripción	Precio
FI5 9267	ARTCI-100	100mm. / sin freno / tornillo	28
FI5 9268	ARTCI-100	100mm. / con freno / tornillo	39

Capacidad de carga: 80 Kg



Cod.	Ø Diam mm	Banda rodadura mm	Capacidad de carga kg	Altura mm	Altura mm	Pletina mm	
FI5 9255 / FI5 9256	100	30	110	132	--	95 x 64	--
FI5 9257 / FI5 9258	100	30	110	--	135	--	12 x 25
FI5 9265 / FI5 9266	100	30	80	132	--	95 x 64	--
FI5 9267 / FI5 9268	100	30	80	--	135	--	12 x 25



ASC / Soporte copas rack / inoxidable

Cod.	Ref.	Descripción	Peso	Precio
F15 9433	ASC1	Soporte copas rack 1 hilera	183 gr	14
F15 9434	ASC5	Soporte copas rack 5 hileras	876 gr	35

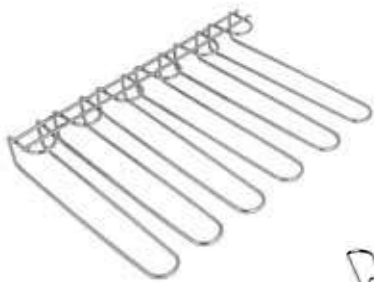
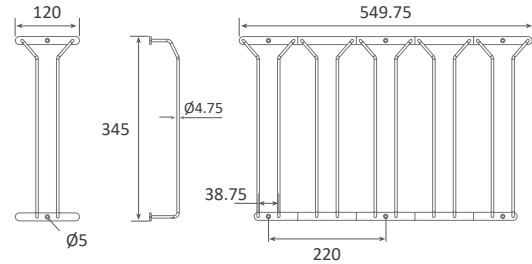

ASC6 / Soporte copas rack / inoxidable

Cod.	Ref.	Descripción	Precio
F15 9435	ASC6	Soporte copas rack 5 hileras	45

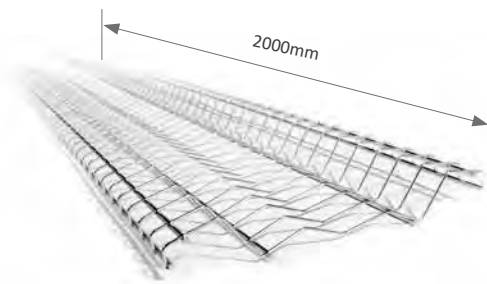
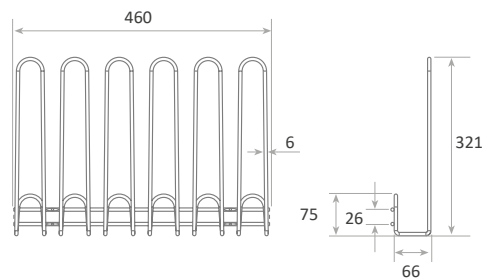

AEP20 / Ecurridor de platos acero inoxidable

Cod.	Ref.	Descripción	Precio
F15 9430	AEP20	Ecurridor de platos 2000 mm	109

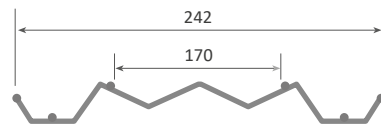

ESUE / Suelo rejilla antideslizante modular

Cod.	Ref.	Descripción	Precio
F15 1495	ESUE	Rejilla suelo antideslizante gis	23

Uniones fáciles y resistentes
 Ideal para su uso en Cámaras Frigoríficas
 Apto para almacenes, barras de bar, lavanderías, etc... Temperatura de uso entre (-40 °C) hasta (+80 °C)
 Rejilla que permita la evacuación perfecta de líquidos
 Fácil instalación y limpieza

Antideslizante, evita resbalones
 Idóneo para combinar con estanterías de Aluminio-Polietileno
 Evite su exposición al sol. Color gris. Dimensiones 500 x 500 x 50 mm.
 Ventas en cajas de 5 unidades



250 W.	250 W.	250 W.	250 W.
220-240 V.	220-240 V.	220V-SPN	220V-SPN
50-60 Hz	50-60 Hz	50-60 Hz	50-60 Hz

Lampara calentadora extensible. Rango de ajuste altura: 600- 1500 mm. Suministrado con roseta para techo. Bombilla incluida



75-200-250 W.

Bombilla calentadora infrarrojos (blanca) con tornillo edison
Apto para pantalla extensible
2000 hrs. vida

ALC / Lámparas calentadoras extensibles

Cod.	Ref.	Descripción	Peso	Precio
FI5 9480	ALC-1-G	Extensible gris 175mm	1.6 Kg	115
FI5 9482	ALC-1-N	Extensible negro 175mm	1.6 Kg	115
FI5 9483	ALC-2-G	Extensible gris 290mm	1.8 Kg	145
FI5 9484	ALC-2-N	Extensible negro 290mm	1.8 Kg	145
FI5 9481	ABCC	Bombilla infrarrojo (blanca)	163 gr	18

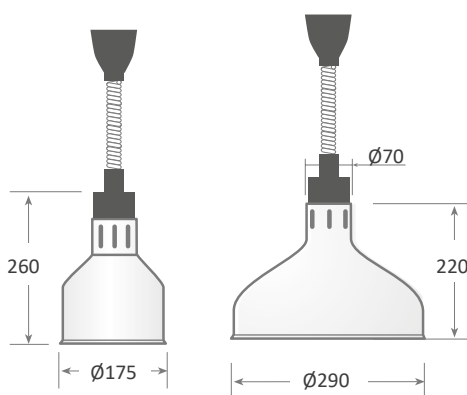

Lamparas iluminación led especialmente diseñadas para instalaciones de productos lácteos, de pastelería, carnicería y charcutería. Para más información, consultar.

ALLBP / Lámparas colgantes LED / Iluminación

Cod.	Ref.	Descripción	Precio
FI5 9545	ALLBP	Led 30W Blanco puro / tulipa azul mate	195
FI5 9546	ALLBC	Led 30W Blanco cálido / tulipa amarillo mate	195
FI5 9547	ALLBR	Led 30W Blanco rosado / tulipa rojo mate	195

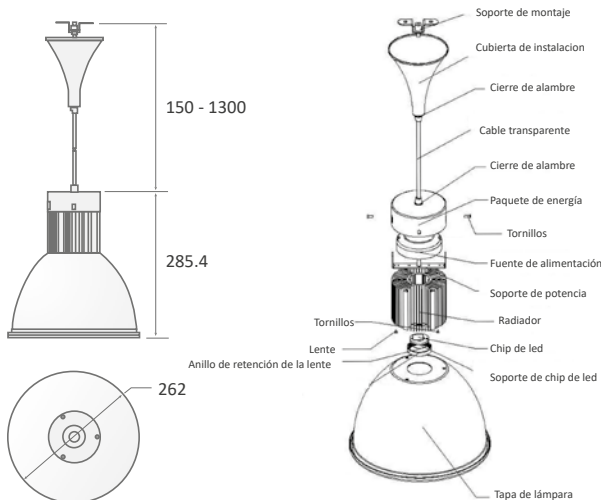

T8 / IP 65



B7 / IP 65



Características del producto

Fuente de luz SMD 2835 de bajo consumo, supone un ahorro de 80% de energía respecto de lámparas incandescentes.

Protección del medio ambiente: No contiene mercurio, plomo ni sustancias peligrosas contaminantes; ni rayos ultravioletas o infrarrojos, para evitar daños al cuerpo humano. Larga vida útil: hasta 50.000 horas.

Nivel de protección: IP65, puede utilizarse en ambientes muy húmedos o con vapor, también soporta agua pulverizada.

Cuerpo de la lámpara: Placa de aluminio y carcasa en dos colores, la parte superior permite un ángulo de iluminación de 120°.

No necesita adaptador.

Aplicaciones

Para montaje de iluminación en congeladores, refrigeradores, estanterías expositoras de: flores, pescados, carnes, charcutería, comidas, supermercados o almacenes

T8 / B7 IP 65	Fuente de LED	SMD2835 (2700-7000K)	SMD2835 (2700-7000K)	SMD2835 (2700-7000K)	SMD2835 (2700-7000K)
	Eficacia luminosa de LED	90-100lm/W-/+ 10%	(La protección opaca tiene una baja eficiencia lumínica pero una alta transmitancia de luz)		
	Flujo luminoso LED	900lm/W-/+ 10%	1750lm/W-/+ 10%	1750lm/W-/+ 10%	1750lm/W-/+ 10%
	Eficiencia luminaria	>85%	>85%	>85%	>85%
	Uniformidad de iluminación	>0.8	>0.8	>0.8	>0.8
	Temperatura de color correlacionada	2700K-7000K	2700K-7000K	2700K-7000K	2700K-7000K
	Índice de reproducción cromática	Ra>80	Ra>80	Ra>80	Ra>80
	Ángulo del haz	120°	120°	120°	120°
	Grado de protección	IP 65	IP 65	IP 65	IP 65



Tubo Led T8

Medida	Blanco cálido ●			Blanco puro ○			Blanco rosado para carne ●		
	Cod.	Ref.	Precio	Cod.	Ref.	Precio	Cod.	Ref.	Precio
600	FI5 9530	T8-600BC	36	FI5 9535	T8-600BP	36	FI5 9540	T8-600BR	46
900	FI5 9531	T8-900BC	54	FI5 9536	T8-900BP	54	FI5 9541	T8-900BR	68
1200	FI5 9532	T8-1200BC	72	FI5 9537	T8-1200BP	72	FI5 9542	T8-1200BR	92
1500	FI5 9533	T8-1500BC	88	FI5 9538	T8-1500BP	88	FI5 9543	T8-1500BR	108

T8 IP 65	Tipo	L 600	L 900	L 1200	L 1500
	Potencia nominal	9W	13W	18W	22W
	Consumo de energía	9W+/-1W	13W+/-1W	18W+/-1.5W	22W+/-1.5W
	Voltaje de entrada	AC85-265 V	AC85-265 V	AC85-265 V	AC85-265 V
	Cantidad LED	48	77	108	137



Regleta Led B7

Medida	Blanco cálido ●			Blanco puro ○			Blanco rosado para carne ●		
	Cod.	Ref.	Precio	Cod.	Ref.	Precio	Cod.	Ref.	Precio
600	FI5 9500	ALLR6BC	18	FI5 9504	ALLR6BP	18	FI5 9508	ALLR6BR	20
900	FI5 9501	ALLR9BC	21	FI5 9505	ALLR9BP	21	FI5 9509	ALLR9BR	23
1200	FI5 9502	ALLR12BC	25	FI5 9506	ALLR12BP	25	FI5 9510	ALLR12BR	28
1500	FI5 9503	ALLR15BC	30	FI5 9507	ALLR15BP	30	FI5 9511	ALLR15BR	33

B7 IP 65	Tipo	L 600	L 900	L 1200	L 1500
	Potencia nominal	6W	9W	12W	15W
	Consumo de energía	6W+/-1W	9W+/-1W	12W+/-1.5W	15W+/-1.5W
	Voltaje de entrada	AC85-265 V	AC85-265 V	AC85-265 V	AC85-265 V
	Cantidad LED	32	51	72	91



ALC / Luminaria para campana



Cod.	Ref.	Medidas Exteriores	Medidas recortadas	Peso	Precio
FI5 9208	ALC62	655 x 272 x 45	615 x 202	3.5 Kg	285
FI5 9209	ALC1225	1255 x 272 x 45	1215 x 202	6.4 Kg	395

Ventajas

Tubos LED probados en el mercado durante 2 años

3 tubos por unidad

Dura hasta 50.000 horas.

Características:

Ajuste sencillo con solo 6/8 tornillos Pozi M6 x 20 mm (incluidos)

Lámpara empotrable delgada (42mm de profundidad)

Controladores integrados en tubos LED (luz blanca 5500k)

Frente de acero satinado con 4mm. vidrio de seguridad templado

Precableado con cable de 2 pies y conector Klik instalado

Unidad eficiente hasta 80°C ambiente.

Unidades garantizadas por 3 años.

Certificación CE y clasificación frontal IP65

Mod.

Potencia

Voltaje entrada

Factor de potencia

Corriente

Temperatura color

Flujo luminoso

Certificación

Soporte lámpara

Consumo

ALC62

10W 0.546

100-240V

> 0.9

AC 50/ 60 Hz

5500 K

1000 LM

CE/EMC/ROHS

G5

3x10W= 30W

ALC1225

20W 1.146

100-240V

> 0.9

AC 50/ 60 Hz

5500 K

2000 LM

CE/EMC/ROHS

G5

3x15W= 45W

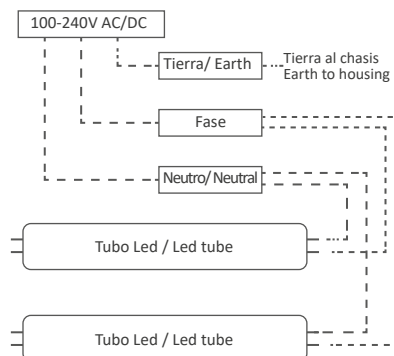
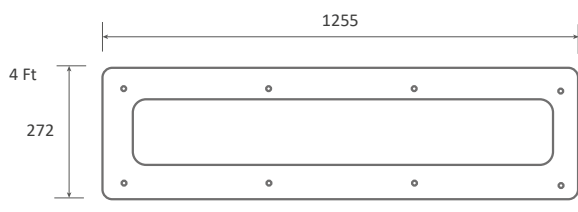
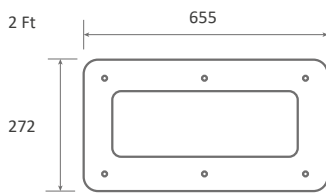

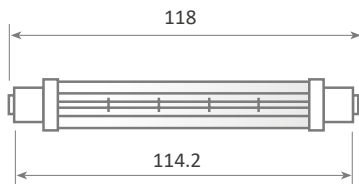

Bombilla de cuarzo revestida 300W / 200W , baja presión

ABCR / Bombillas de cuarzo revestidas

Cod.	Ref.	Descripción	Peso	Precio
FIS 9550	ABCR3	Cuarzo revestida 300W	64 gr	19
FIS 9551	ABCR2	Cuarzo revestida 200W	64 gr	19

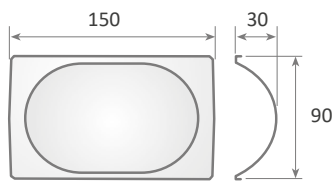

ARC / Reflector

Cod.	Ref.	Descripción	Peso	Precio
FIS 9553	ARC	Reflector	40 gr	4

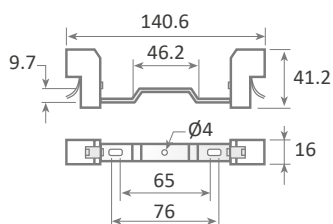

ASRC / Soporte para bombilla JV

Cod.	Ref.	Descripción	Peso	Precio
FIS 9554	ASRC	Soporte 309	60 gr	7

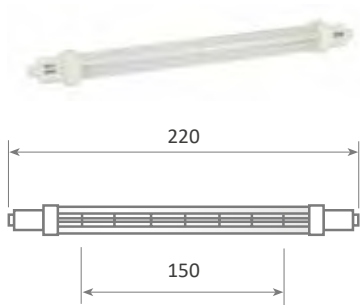

Bombilla de cuarzo revestida 300W / 500W.

ABRCPJ / Bombillas de cuarzo revestidas

Cod.	Ref.	Descripción	Peso	Precio
F15 9555	ABRCPJ3	Revestida cuarzo 300W	102 gr	42
F15 9556	ABRCPJ5	Revestida cuarzo 500W	102 gr	42

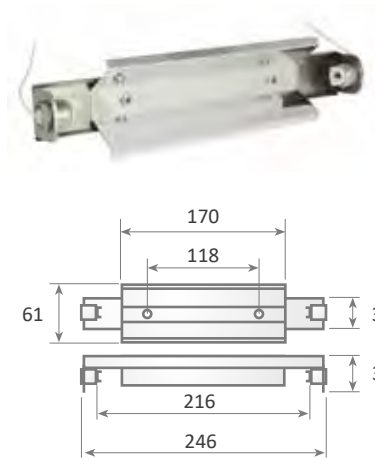

ASBRCPJ / Reflector

Cod.	Ref.	Descripción	Peso	Precio
F15 9557	ASBRCPJ	Soporte reflector	320 gr	33



ALC / Lámpara de cerámica

Cod.	Ref.	Descripción	Peso	Precio
F15 9558	ALC3	Cerámica 300W	256 gr	52
F15 9559	ALC5	Cerámica 500W	256 gr	52



QVR / S Variable 15A + ve, cables , perilla y bisel

ARI / Regulador de intensidad

Cod.	Ref.	Descripción	Peso	Precio
F15 9560	ARI	Regulador 15A max. 3.9 Kws.	150 gr	86

Tipo de ángulo de fase
 Capacidad máxima de 3.9 kw
 Estándar 230V
 El instalador debe usar un disipador de calor y pasta de disipador

QVR/S 230 V Corriente:
 15 A
 Anti RFI: No
 Tipo de conexión: Cable